

GRAYS HARBOR RACEWAY

360 Sprint Car Rule Book

Grays Harbor Raceway | Circle Motion Promotions, LLC | P.O. Box 1984 | Snohomish WA 98291
Office: 360-482-4374

Web Site: www.graysharborraceway.com

E Mail: graysharborraceway@hotmail.com

DISCLAIMER

The rules and regulations set forth are designed to provide for the orderly conduct of racing events and to establish minimum acceptable requirements for such events. These rules shall govern the condition of all events and by participation in these events, all participants are deemed to have complied with these rules.

The minimum requirements set forth may change at the discretion of the management of Grays Harbor Raceway.

No expressed or implied warranty of safety shall result from publication of or compliance with these rules and/or regulations.

They are intended as a guide for the conduct of the sport and in no way guarantee against injury or death to a participant, or any other individuals that enter the property.

RACING IS A DANGEROUS SPORT. PARTICIPANTS AND ALL OTHERS THAT ENTER GRAYS HARBOR RACEWAY PROPERTY CAN BE SUBJECTED TO INJURY OR DEATH. YOU ASSUME YOUR OWN RISK AND RESPONSIBILITY WHILE ON GRAYS HARBOR RACEWAY PROPERTY.

GRAYS HARBOR RACEWAY RULES

COMMON SENSE AND THE SPIRIT OF INTENT WILL PREVAIL FOR THE INTERPRETATION OF ALL RULES.

SPIRIT OF THE RULE

Although every effort has been directed towards complete, understandable, and correct rules, Grays Harbor Raceway can't possibly anticipate every situation, circumstance, or interpretation. With this in mind, we must refer to the **SPIRIT OF THE RULE**. Spirit of the Rule means very simply, the intent of every rule and classification. Additional adjustments, alterations, modifications, and/or replacements not covered by written rules should NOT be assumed to be legal under the **SPIRIT OF THE RULE**. **SPIRIT OF THE RULE** will be the final criteria by which rules will be interpreted and enforced.

IT IS THE CAR OWNERS RESPONSIBILITY TO READ AND UNDERSTAND ALL RULES AND REGULATIONS. IF YOU DON'T UNDERSTAND ASK THE RACE DIRECTOR OR PROMOTER.

1. Entry – Participation

The management of Grays Harbor Raceway reserves the right to refuse entry to anyone at any time for any reason.

2. General Rules

2.1 All participants and individuals shall abide by and obey all rules and regulations.

2.2 All participants and individuals are responsible for their own personal conduct. The car owner(s) are responsible for their driver's and crew member's conduct at all times.

2.3 Drivers must exercise care to avoid injury to track workers, officials, spectators and other individuals when operating a race car.

2.4 All fines must be paid prior to the individual(s) returning to Grays Harbor Raceway.

Fines may be deducted from team earnings in which the violator is associated with.

- 2.5** No switching of numbers or qualified cars after race program has started.
- 2.6** If a spare car is to be used once the program has started, it must not have been qualified previously that night and will start in the rear of the qualified field.
- 2.7** Cars must be neat in appearance. No graphic, obscene or offensive images allowed.
- 2.8** Numbers for scoring should be 16" tall and if a letter is added it should be minimum 6" tall.
- 2.9** Car owners or drivers that refuse an inspection on any item will be considered illegal.
- 2.10** Cars that are illegal will be disqualified for events participated in that night.
- 2.11** Illegal engines will result in a fine of up to **\$1,000.00** and loss of all points to date.
- 2.12** Engines that pump big will have the option to tear down for cubic inch verification.
- 2.13 Management reserves the right to check any cars for rule compliance at any time.**
- 2.14 In order to protest a competitor's motor, (Owner or Driver) protestor's car must have finished in the same race as the protested car. Protester (Owner or Driver) must put in writing, and present to the Race Director within 15 minutes of the checkered flag. Protester must include, in writing what area (Rule/Item) is being protested and accompany it with \$1,000.00 cash. If protested car is illegal, \$750.00 will be returned to protester. If protested car is legal, \$750.00 will be awarded to said car for reassembly inconvenience. The balance will pay the Management and technicians.
- 2.15 All other protests must be in writing by affected car owner from same event.**
- 2.16** Grays Harbor Raceway management reserves the right to add, delete or modify any and all rules at any time to ensure a fair and competitive venue for all competitors.

3. Participants

Participants are individuals who are admitted to the restricted area.

4. Areas of Grays Harbor Raceway to which rules apply:

4.1 Restricted area: All of the facility which is within the fences that surround the actual racing surface, pit areas and trailer parking lot.

4.2 Pit area: All of the facility which is within the fences that surround the actual racing surface, within which the race vehicles are held and maintained while not on the racing surface.

4.3 Grandstand area/general parking area: Grandstands and the concession area as well as area used for spectator and employee parking during events.

4.4 No firearms allowed in the pit area.

5. Age Restriction

All drivers should be at least **sixteen (16)** years of age. **Drivers under age 16 with prior experience may request a variance.** Must follow the age RECOMMENDED REQUIREMENTS as HIGHLY RECOMMENDED by our INSURANCE COMPANY prior to participating at Grays Harbor Raceway and must be approved prior to entering any event. Refer to the age guidelines on our website and follow the request procedures in advance.

All Drivers age of 16 AND 17 must follow the age RECOMMENDED REQUIREMENTS as HIGHLY RECOMMENDED by our INSURANCE COMPANY prior to participating at Grays Harbor Raceway and must be approved prior to entering any event. Refer to the age guidelines on our website and follow the request procedures in advance.

Individuals **under the age of eighteen (18)** must have a **signed**, minor release consent form from **parent** or legal guardian on a form supplied by Grays Harbor Raceway, and signed in front of staff to enter the restricted area.

6. Alcohol / Marijuana

Possession and or consumption of alcoholic beverages and/or **Marijuana** prior to or during an event are strictly prohibited. Persons under the influence of alcoholic beverages and/or **Marijuana** in the restricted areas may be fined up to \$500.00 and denied access to the restricted area.

7. Illegal Drugs

The use, possession, sale or transfer of illegal drugs on Grays Harbor Raceway property is strictly prohibited. Violators will be fined and denied access to the entire Grays Harbor Raceway property. Violators will be reported to the sheriff's office.

8. Prescription Drugs Any participant using over the counter medication or medication prescribed to them by a physician that may restrict or impair their ability to perform a task should not attempt to perform the task.

9. Unsportsmanlike conduct

9.1 Any physical, verbal or written misconduct which the track management deems detrimental or that distracts from the orderly and peaceful conduct of the racing at Grays Harbor Raceway is strictly prohibited. Violators may be fined a minimum \$250.00 and may be denied access to the restricted area for a minimum of two weeks.

9.2 If the misconduct is directed toward Grays Harbor Raceway management, officials, track workers, employees or volunteers, the person(s) involved with the violation may be immediately removed and denied access to the property of Grays Harbor Raceway. A minimum fine of \$500.00 and suspension may be imposed.

9.3 No individuals shall use loud and/or abusive language in addressing track management or officials. Violators may be fined a minimum of \$100.00 and possible suspension.

9.4 All fines levied against an individual or team may be withheld from car earnings.

10. Unspecified Violations

The track management and officials may impose such penalties as they find appropriate for the situation. The decision of the management and officials shall be final.

10.5 Car Owner and Driver are Responsible for

WASTE OIL: MUST BE PLACED IN THE WASTE OIL BARRELS AT THE DESIGNATED WASTE OIL AREA. FAILURE TO DO THIS WILL RESULT IN A MINIMUM FINE OF \$200.00

TIRES: TAKE THEM WITH YOU, DO NOT LEAVE THEM AT THE TRACK OR FAIRGROUNDS. FAILURE TO DO THIS WILL RESULT IN MINIMUM FINE OF \$200.00

GARBAGE: IN YOUR PIT AREA, CLEAN UP YOUR AREA AND USE THE TRASH CANS AVAILABLE THROUGHOUT THE PIT AREA.

11. Packing the Track

11.1 All persons packing the track must sign in at the pit gate as a driver.

11.2 All persons packing the track must wear all appropriate safety gear and follow packing directions from track workers. Anytime a car is on the track the driver must maintain a minimum 3' (36 inches) between the car and any track worker or official.

12. Racing Rules

12.1 Pit speed limit is 10 miles per hour.

12.2 All cars returning to the pit area under power must use designated pit entrance.

12.3 In the event a race is cancelled after 50% completion, it will be scored completed.

12.4 All cars receive one push off per event. If a second push off is needed, the car must start at the rear of the lineup. Red flag and safety stops excluded. **All safety stops should be on the front chute at the flag stand area.**

12.5 Any qualified car that did not start at the original start of the event and was not replaced by an alternate car may join the event at the rear on the next race stoppage, provided the event has not exceeded 20% of said event at the discretion of the Race Director.

12.6 Drivers causing two stoppages in a single event will be disqualified for event.

13. Flags

13.1 Green Flag

13.1.1 The green flag will indicate the start or restart of an event. After the cars are lined up in the correct order, the (yellow) traffic lights will be turned off; this indicates the race will start on the next exit out of turn four. In the event of a false or poor start, the yellow caution light will come on as the leaders reach the backstretch. The start will then be reattempted.

13.1.2 If one or both front row starters jump the second start, they will be moved back a row for the next start. **If a driver has a blatant excessive jump on the original start he/she may be put back a row.**

13.1.3 Any car(s) advancing positions before the start or before the cone on a restart will be penalized two positions for each position gained. Penalty will be assessed at the next race stoppage or end of the event.

13.1.4 Any driver that hits the cone on a restart will be put to the back immediately unless the driver is avoiding a collision. A second infraction will result in disqualification. **If a driver is alongside the car in front of him at the cone he must let the car back in front of him before the exit of turn 2 or be penalized for jumping.**

13.1.5 Restarts after one lap is completed will be single file. No gaping or passing before you pass the cone.

13.2 White Flag

13.2.1 The white flag indicates one lap remaining in the event.

13.2.2 Should the race be stopped on the last lap, the restart will consist of two laps at green, white and then checkered.

13.3 Black and White Checkered flag

13.3.1 A checkered flag will indicate the end of an event.

13.3.2 If the leader receives the checkered flag and the race is stopped before all cars cross the finish line, the race will be scored complete. The cars crossing the finish line before the stoppage will be scored accordingly, the remaining cars will be scored as they had completed the previous lap. Cars involved in the stoppage will be scored last on their respective lap.

13.4 Yellow Flag

13.4.1 A yellow flag condition is considered a race stoppage. Cars will slow to a pre-race speed and maintain a single file line. Cars out of position will be advised by track officials **and / or over the Raceceiver frequency** where to line up.

13.4.2 If a pace truck is on the track, **no cars are allowed to pass** it without permission. Violators will be sent to the rear of the field or disqualified.

13.4.3 Cars entering the work area during a yellow flag condition, that complete the work before the race is ready to resume will be allowed to restart at the rear of the lineup. Lineup will be in the order they return to the track.

13.4.4 Cars involved in the race stoppage that go to the work area will be given the time it takes the pace truck to complete two laps past the flagman to make repairs. The laps begin when the last car involved arrives in the work area. Lineup will be in the order they return to the track. **Cars not involved in the race stoppage that go to the work area will not get a two laps work period. The race will resume when the lineup is correct. Any driver causing two yellow flags will be disqualified for that event.**

13.5 Red Flag

13.5.1 A red flag condition is considered a race stoppage. Cars that blatantly drive past the crash scene will be penalized **Two (2) positions** or disqualified **at the Race Directors option**.

13.5.2 Cars stopping must stay off the inner apron and not block openings where emergency personnel or support vehicles respond from.

13.5.3 Cars entering the work area during a red flag condition that complete the work before the race is ready to resume will be allowed to restart at the rear of the lineup. Lineup will be in the order they return to the track.

13.5.4 Under red flag conditions: On a **"Closed Red"**, **No crewmen or individuals are allowed on the track. Violation will result in a disqualification.**

13.5.5 On an **"Open Red"**, The crew may work on the car on the track. If a tire change is required, the car must go to the work area, see 13.5.2

13.5.6 If fuel is added, the crew must have a **manned fire extinguisher** at the car and use an **anti-slosh funnel**. Violation of this will result in disqualification.

13.5.7 If a car is involved in an accident, only emergency personnel and **two** crewmen are allowed at the car until the driver has vacated. Crew members must follow the direction of the emergency personnel.

13.5.8 Persons not directly involved with the car(s) involved in the accident must stay back. Violation of this will result in a fine.

13.5.9 When the "Clear the Track" command is given, all personnel must leave the track in a timely manner. Violation of this will result in the car being penalized to the rear of the line up or disqualification.

13.6 Black Flag

13.6.1 If a driver receives a black flag during an event, driver must enter work area for explanation. Drivers receiving a black flag will leave the track immediately, failure to do so will result in disqualification from that event and may be fined.

13.6.2 Drivers that are black flagged for mechanical or safety reasons may return to the event once repairs are made and the track is open.

13.6.3 If a driver is black flagged and stops to create an intentional yellow, driver is subject to a penalty or fine.

13.6.4 A furled black flag will be a warning against on-track violations.

13.7 Blue Flag with a Yellow Stripe: If a driver receives a blue flag with a yellow stripe. It means hold your groove leaders are coming up upon you.

13.8 Re Entry

No cars are allowed to enter the racing area after the track and / or pace truck caution lights are turned off.

14. Safety Rules– It is the car owners responsibility to ensure his/her car is safe and properly maintained for racing.

14.1 No modifications of any manufactured safety products allowed.

14.2 The following must be worn during any event other than wheel packing. All applicable items must be nomex and SFI rated.

14.2.1 **Snell SA 2010** or newer full face helmet required.

14.2.2 Arm Restraints

14.2.3 SFI fire suit, minimum two layers. Fire retardant Underwear, Head & Foot Socks.

14.2.4 Fire retardant neck collar or Hans type neck collar recommended.

14.2.5 Fire retardant gloves and racing shoes.

14.3 When wheel packing, drivers suit, gloves and helmet mandatory.

14.4 Right side head net, **or approved head restraint seat.**

14.5 Current five point seat belt harness. Each car will be equipped with minimum of an SFI 16.5 or SFI 16.1 approved restraint system. UNTIL THE DATE OF THE BELT EXPIRATION

(TWO YEARS FROM THE DATE OF MANUFACTURE). LATCH TYPE 5-POINT SEAT BELTS mounted per manufacture. (must have Label) Seat belt restraint systems shall be installed and used in accordance with manufactures instructions. In any type of manufacture's installation, the fasteners must be magnetic steel unless using type of mount in which seat belts wraps around the roll cage. A seven-point harness is recommended. Seat belt material should not be permitted to come in contact with any sharp or metal edge, including when the material passes through the seat.

- 14.6** Approved roll bar padding on roll bars within range of drivers head.
- 14.7** High-back approved racing seat. Minimum three 5/16" mounting bolts.
- 14.8** Padded knee guards.
- 14.9** Driveline hoop. Minimum 1" O.D. x .065 4130 chrome alloy material.
- 14.10** Sealed firewall between the driver and engine.
- 14.11** Hood must cover radiator cap and engine.
- 14.12** Floor pan must be securely fastened and extend to each frame rail and from the motor plate to the seat. Not allowed under the engine or fuel tank.
- 14.13** Throttle pedal must have toe strap. Not recommended to mount to floor pan.
- 14.14** Main fuel line must have ¼ turn shut off if fuel pump is mounted in front of motor.
- 14.15** Fuel lines must be reinforced pressure hose. No plastic lines.
- 14.16** Approved fuel tanks with bladders only. Flush mount caps and non-spill vents. **Fuel tanks shall retain the traditional sprint car tank shape, no square back shapes.**
- 14.17** On/off or push/pull ignition switches only. No keys.
- 14.18** No mirrors or communication devices **except Raceceiver. Only track official may talk to drivers, violators will be disqualified & fined \$250.**
- 14.19** Driveline must be enclosed in driver's compartment.
- 14.20** No external coolers.
- 14.21** No **clip on** wheel weights.
- 14.22** Wheel wing nuts not to extend past rim.
- 14.23** All wheels must be approved for racing.
- 14.24** All hubs must be approved for racing.
- 14.25** Wheel covers must be attached by **minimum 5 Dzus fasteners or 3 5/16 flangehead bolts. Approved fastening systems: Keyser Manufacturing, part #100 7-101. Wehrs Manufacturing Part # (WM377A-312 Aluminum 5/16) (WM377S-312 Steel 5/16) Triple X Chassis Part # SC-WH-7810 (for 1" spring) / SC-WH-7820(for 1 3/8" spring) Smith Precision Products Part # MC-516-18**
- 14.26** Foot operated hydraulic brakes that work required.
- 14.27** All cars must have top wing at all times.
- 14.28** Roll cage must be 2" above drivers Helmet.
- 14.29** **Drag Link and LF radius rod must be made of 4130 steel with steel rod ends. Drag Link must be tethered to frame.**
- 14.30** **TORSION ARM STOPS MANDATORY** on both sides of the front torsion bars. The retainer may be of the rod-type with a securing cap or insert with an expanding mandrel, any other Torsion arm stop design must be approved by track Tech. Torsion arm stops must be installed and used in accordance with the manufacturer's instructions.
- 14.31** **Axle tethers and Kingpin tethers are highly recommended. Tether systems should be installed and used in accordance with the manufacturer's instructions.**
- 14.32** It is recommended that teams have in the rear of their transporter an easily accessible fire extinguisher of at least 2.5 gal FFF or equivalent.
- 14.33** **Fire suppression systems are highly recommended. If a fire suppression system is installed, it must be installed and used in accordance with the manufactures instructions, installed securely and meet or exceed SFI 17.3 Specifications.**

15. Chassis Rules All Sprint Classes

15.1 Space frame design only. Roll bars must be 4130 chrome alloy. Minimum size of roll cage will be 1 ¼" X .120 WALL OR 1 3/8" X .095. Cage bracing must be minimum 1' x .065. Must be of modern and normal design.

TORSION ARM STOPS WILL BE MANDATORY on both sides of the front torsion bars. The retainer may be of the rod-type with a securing cap or insert with an expanding mandrel, any other Torsion arm stop design must be approved by track tech. Torsion arm stops must be installed and used in accordance with the manufacturer's instructions.

2019 forward all chassis will be require to have additional bars installed to support and decrease the span between the front and rear uprights. The new support bars must be an addition to the front and rear uprights. The left and right side support bar do not have to be the same. These additionalbars will be minimum 1.375 X .083 ASTM4130 normalized steel or equivalent material. Left and right side support bars may be one of two forms a "Curved Support Bar" similar to current "safety bar" used in some chassis' or a "Non-Curved Support Bar" similar to the WoO Craftsman Sprint Car Series Rules.

The Curved Support Bar will attach to the top rail to create a span between 15" and 20" from the front upright to the support bar. This measurement will be made from the rear point of the front upright to the forward point of the support bar. It will attach to the hip rail and have a gusset attached above the curve to the rear upright at the point opposite of the rear brace/shock mount bar. The outer most point of the curve will be between 4" and 7" measured from the outer edge of the uprights.

The Non-Curved Support Bar will be attached to the top rail to create a span between 15" and 20" from the front upright. This measurement will be made from the rear point of the front upright to the forward point of the support bar. The bottom of the Support Bar will attach to the rear upright at the point opposite of the rear brace/shock mount bar. See drawings below.

Support Bar

Distance of spread between 15" and 20"

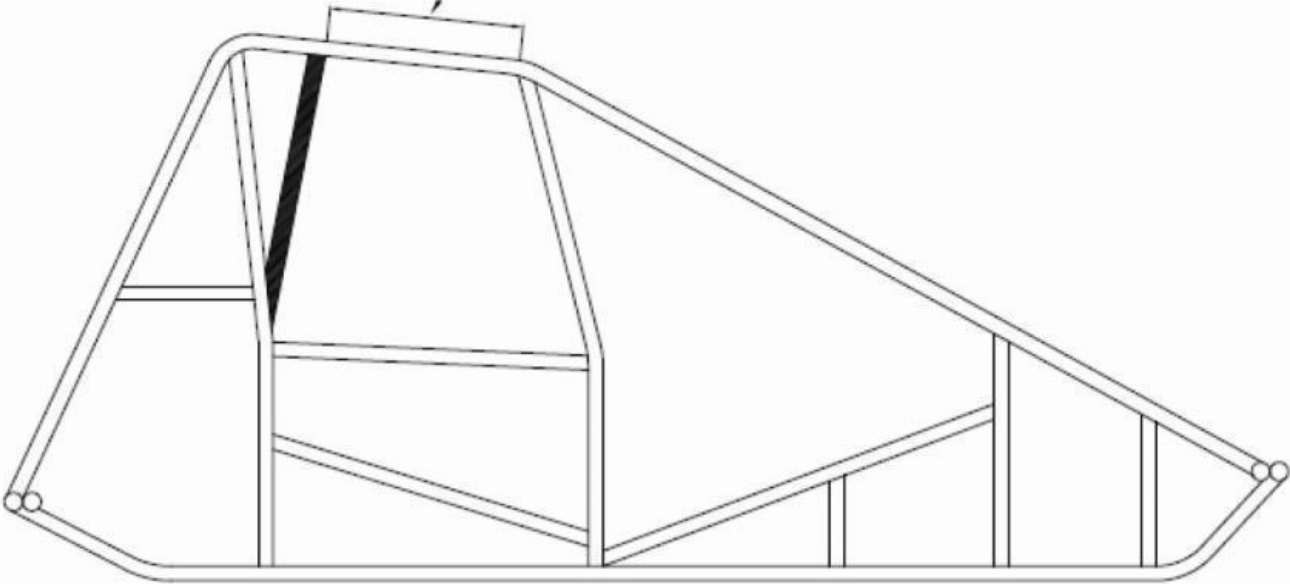

Curved Support Bar Drawing

Distance of spread between 15" & 20"

Distance of spread between 15" & 20"

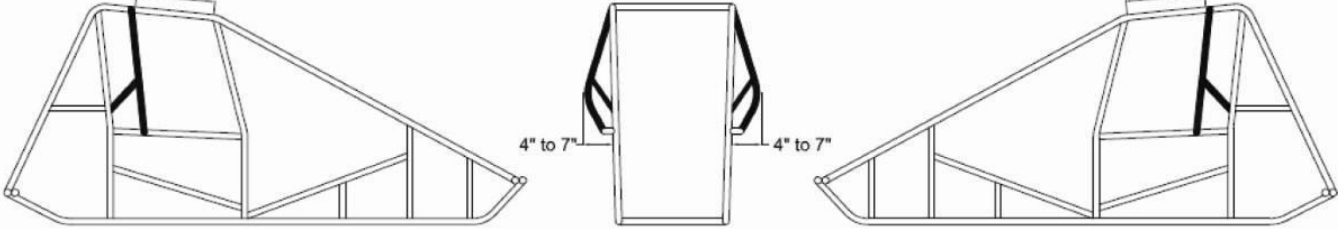

#3 Support Bar Curved Option

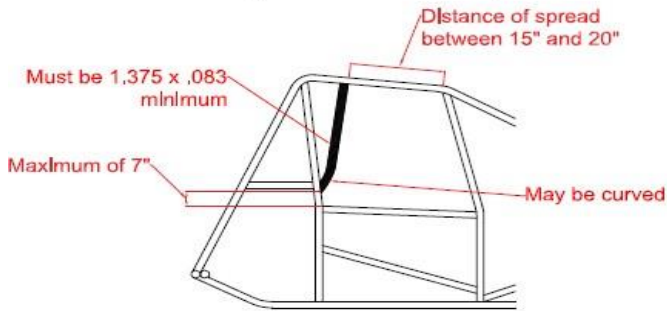

#3 Support Bar

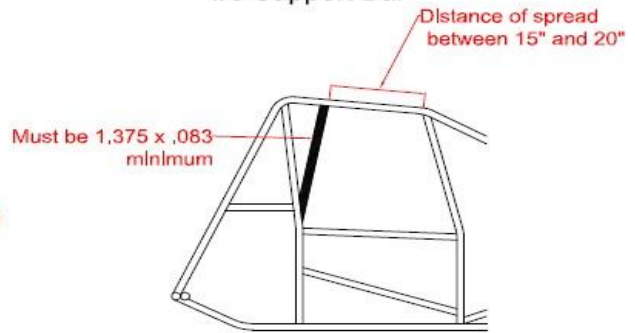

Drawing 16.12.3
By Tom Devitt

Distance of spread between 15.. & 20"

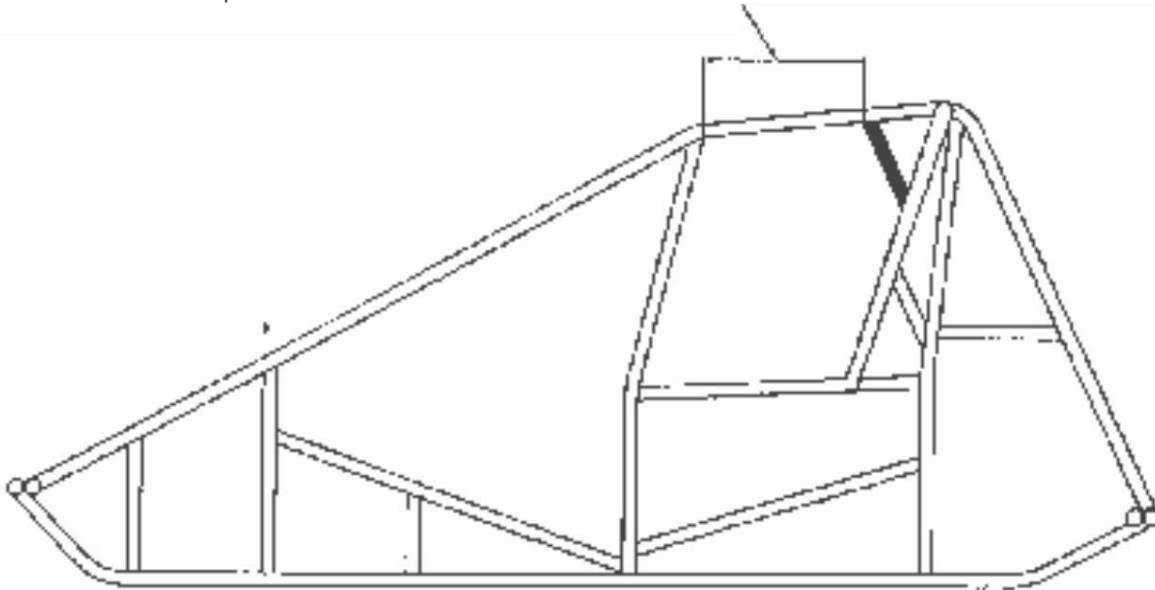

15.1.1 Slip joints will no longer be allowed in any form. Bolted or clamped slip joints will no longer be allowed. If a current chassis has a slip joint it will have to be welded the full circumference of the tube to become solid.

15.2 Front, rear and side nerfs required at the start of the race. All nerfs and bumpers must be attached with a minimum 3/16" steel fastener. No pop rivets.

15.3 Side nerfs not to extend past tires. **Nerfs must be attached to the chassis at 3 points.** Front nerf minimum 12" wide and rear nerf minimum 6" vertical contact area. All nerfs and bumpers must be steel. Minimum 1" O.D. No air deflectors on nerfs or bumpers.

15.4 Wheel base minimum of 82". Tread width minimum of 48" center to center.

15.5 No traction control devices. Violators will be fined and suspended.

15.6 Coil, power boxes and all electrical components must be on engine side of firewall.

15.7 No electrical disconnects in cockpit.

15.8 Body style and design must look like a standard and normal sprint car. **No unusual shaped or added panels to deflect or catch air.**

15.9 All tires must be "Hoosier". **RR H15 105/16-15 or 105/18-15 HTW** or 105/16.0-15 Medium compound. LR 15.0/90, 92, 94, 96-15 H12 or H15 Compound, D10 and RD 12 compound also allowed. Front 85/8.0-15 D10, D12.

15.10 No cockpit adjustable parts except wing slider.

15.11 Brake rotor material optional.

16. Wings All Classes

16.1 Top wing surface area not to exceed 25 square feet.

16.2 Nose wing top surface shall be maximum 6 square feet.

16.3 Top wing side panels maximum vertical height is 30".

16.4 No dual stage wings.

16.5 No offset or angled shape to the body or side panel design.

16.6 Side panels mounted at 90 degrees to the main body.

16.7 Side panel length not to exceed 12" total past the front or rear of main body.

16.8 Wing T-post should be built from 1" X .083" minimum ASTM4130 normalized steel or equivalent material. Parts made from castings must be HRP Heat treated type.

16.9 1" Wicker bill allowed on nose wings.

16.10 360 specifications:

16.10.1 Curved top wings may not exceed 2 1/2" of total dip in the top surface measured from front to back. No wickers bills allowed.

16.10.2 Top wing may be of 'Flat Top' design. Main body thickness not to exceed 9". Maximum 2" wicker bill allowed.

17. Weight Rule

17.1 All classes are minimum weights at the conclusion of an event and include the driver. **No allowance for parts lost during the event.**

17.1.1 360 class 1475 lbs.

17.2 Cars found underweight will be **disqualified** and forfeit money and points for said event.

17.3 Added weight must be between frame rails and axles, securely fastened. **No single weight over 20LBS, painted white and have the car number on it. Must meet tech approval.**

17.4 All cars weighing will have a crew to push car on & off scales.

17.5 Top three cars from each heat and main must weigh before returning to pit stall. Cars that do not stop and weigh may be disqualified. **If in doubt, STOP at the scales. Only exception is if no weigh ins are announced by the Management or Race Director.**

18 Engine Rules All Classes

18.1 Methanol fuels only. No performance enhancing additives. **Including but not limited to Nitromethane and propylene oxide.**

18.2 Normally aspirated, piston driven engines only.

18.3 Injectors must be individual stack per cylinder design with single round butterfly.

18.4 Sprint Class

18.4.1 Maximum cubic inch 360

18.4.2 No titanium cranks or rods.

18.4.3 Steel blocks only.

18.4.4 Injectors: 2 3/16 inch maximum inside diameter of injector stack - 2.187 at least 3 inches in length. Note: Larger injectors may be used, but sleeves a minimum of 3 inches in length must be installed in stacks above the Butterflies. No

relief hole may be drilled above the Butterfly on any injector. No Alteration of injector manifold mounting holes will be allowed.

18.4.5 Aluminum heads are permitted. Cylinder heads **can** be legal ASCS heads. **Must be 23 degree (+/- 2 degree).** We will be evaluating the non-ASCS head rule at the end of the **2023** year and deciding whether to continue to allow non-ASCS heads. **May also be re-evaluated during the 2023 season.**

18.4.6 Injector nozzles not permitted in the cylinder head.

18.4.7 **Oil pan must have a 1" inspection plug** on the side.

19. Mufflers

Unaltered, functional mufflers intact at all times. Large oval Flow Master (**#5354510**), Large Spin Tech box mufflers (**#1555**) or Schoenfeld (**#14272735**). **Max dba 95 @ 100'.**

19.1 MAX 23 DEGREE TURN DOWNS.

20. Race Format

20.1 Qualifying

20.1.1 **Sprint cars will draw a pill for qualifying order. All car to tech (scales) after their qualifying lap upon leaving the track and before going to their pit.**

20.1.2 If a car is unavailable and misses its qualifying spot by more than two cars, said car will take one lap at the end. **The best the car can start is behind the inversion of the heat race.**

20.1.3 Cars that are too loud are disqualified and may change mufflers and take one lap at the end. **The best the car can start is behind the inversion of the heat race.** Cars that don't meet the dba requirement will not race.

20.1.4 Cars that take one lap at the end may not start the 'A' main any further up than the back of the inversion or fifth, whichever is greater.

20.1.5 If an event is delayed and qualifying is cancelled, heat races will be lined up according to car owner points. #1 on the pole of heat one, #2 on the pole of heat two, #3 on the pole of heat three, etc.

20.1.6 If a car in any class has not drawn a pill before 4:00pm, it will retain the next highest number available for said class.

20.2 Heat Races:

20.2.1 Sprint cars will line straight up by their qualifying time with the top 4 inverted.

20.2.2 Classes with 27 or less cars will have two or three heats. The top five cars will retain their time and transfer to the 'A' main, provided they attempted to take the checkered flag.

20.2.3 Classes with 28 or more cars will have four heats. The top four cars will retain their time and transfer to the 'A' main, provided they attempted to take the checkered flag.

20.2.4 Sprint heat race transfer cars will line straight up by their original qualifying time with the inversion for the 'A' main start, provided they take the checkered flag in their heat.

20.2.5 You must take the checkered flag in your heat to get your time back. If you do not take the checkered flag, you will start behind the transfer cars. In the event of a "B" main, you will be lined up in the "B" main by your time.

20.2.6 Classes with 19 or more cars will have a 'B' Main.

20.3 "B" Main Event:

20.3.1 The 'B' main will line straight up by original qualifying time or pill draw. Transfer cars to the 'A' main will start at the rear of the 'A' main according to 'B' main finish.

20.3.2 If a 'B' main is cancelled, cars that did not transfer directly into the 'A' main from their heat race will be lined up from the start of the 'B' main.

20.3.3 'A' main cars that scratch after their heat race will be replaced by additional 'B' main transfers.

20.4 "A" Main Event:

20.4.1 The car(s) with the fastest qualifying time and/or lowest pill draw will roll the dice or draw a chip to determine the 'A' main inversion of '0', '4', '6', '8' or Full Invert.

20.4.2 'A' main will be up to 18 cars. It is the Promoter's option to add cars.

20.5 New or inexperienced drivers will start at the rear of all races for at least two weeks or until officials notify driver he can start in qualified spot.

20.6 Cars that enter the work area with 5 laps or less remaining in the race will not be given the 2 lap wait period for repairs. When the lineup is correct the race will resume.

20.7 Lapped cars will be put in running order behind the lead lap cars when 5 laps or less remain.

20.8 Top three to tech in heats and mains.

21. Point System

21.1 Equal points will be awarded to the driver and the car owner for each event.

21.2 On Mid-season the format will be a regular event format with qualifying, heats and mains.

21.3 Championship night the top six (6) in car owner points will be locked into the 'A' main straight up by points, they will race a six lap scramble race. The finish determines the starting lineup for each main. All other cars will qualify and start straight up behind the six scramble cars .

21.4 Switching car number and driver not permitted.

21.5 Points

Qualifying	Heat Race	Main Event	Optional	
1 = 8	1 = 10	1 = 40	10 = 22	19 = 4
2 = 7	2 = 9	2 = 38	11 = 20	20 = 2
3 = 6	3 = 8	3 = 36	12 = 18	21 = 1
4 = 5	4 = 7	4 = 34	13 = 16	
5 = 4	5 = 6	5 = 32	14 = 14	
6 = 3	6 = 5	6 = 30	15 = 12	
5 = 2	7 = 4	7 = 28	16 = 10	
4 + 1	8 = 3	8 = 26	17 = 8	
	9 = 2	9 = 24	18 = 6	
	10 = 1			

21.6 All cars not transferring from the "B" will receive 1 point.

21.7 If the "A" feature is a Full invert, there will be awarded one (1) point for each position gain from the original official starting position.

22. Banquet and Point fund

22.1 To receive a trophy and / or point fund check, 3 criteria's must be met:

22.2 Car owner(s) competing under the same number must compete in a minimum 80% of the point's races.

22.3 Car owner must be in good standing with Grays Harbor Raceway.

22.4 Car owner and/or driver must attend the banquet.